

efi sales Ltd.

Equipment for the Foodservice Industry
value + quality + service

Hamburger Patty Maker - 5"

SA-HF05



SA-HF05

Features

Features:

- Anodized aluminum body
- Food grade stainless steel for all food contact areas
- Produces 5" patty, approximately 160 grams each
- Easy to operate and clean



SA-HF05

Specifications

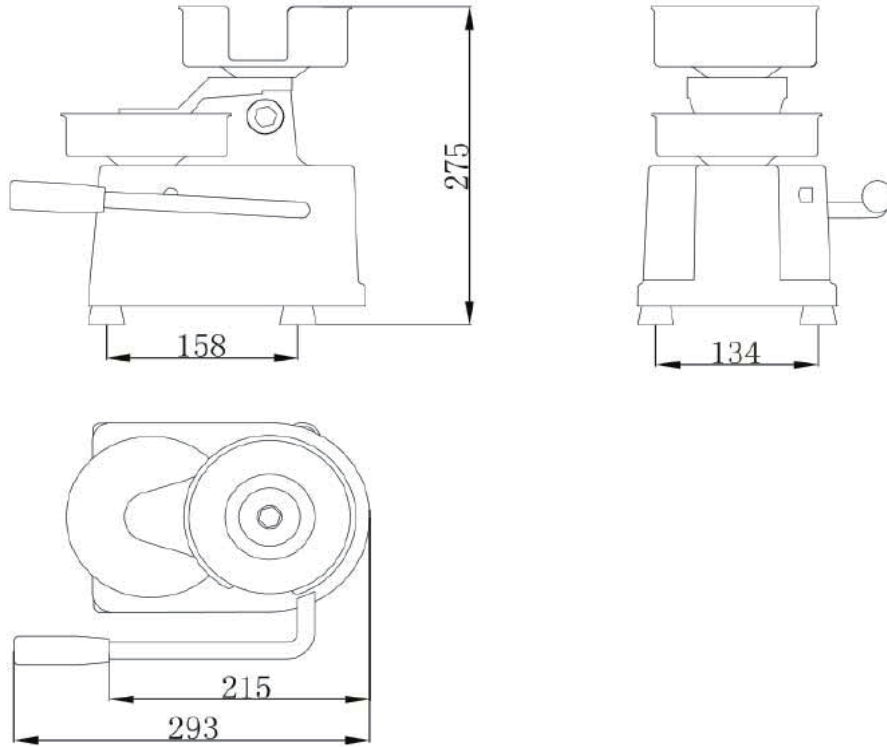

Model	Dimension (mm) (inch)			Hamburger Patty Size	Weight of Patty	Net Weight (KG) (LBS)
	W	D	H			
SA-FWHF05	210	293	275	5" Patty	160 grams	5.8
	8.3	11.5	10.8			12.8

Shipping Information

Crate Dimensions (mm) (inch)			Net Weight (KG) (LBS)	Gross Weight (KG) (LBS)
W	D	H		
245	305	330	5.8	6.4
9.6	12.0	13.0	12.8	14.1

Specifications subject to change without notice.