



Equipment for the Foodservice Industry

value + quality + service

Work Top Refrigeration

CWDW2-48VC



CWDW2-48VC

Features

Features:

- Exterior & interior stainless steel construction
- Heavy duty Embraco compressor
- Self-closing and stay open door
- Efficient refrigeration system
- Recessed door handle
- Removable gasket that is easy to clean and replace
- Casters for easy movement
- Pre-installed shelves

Warranty:

- Two year parts and labour; Five years on compressor. For full warranty details visit <https://www.efifoodequip.com/warranty-info.php>



CWDW2-48VC Specifications

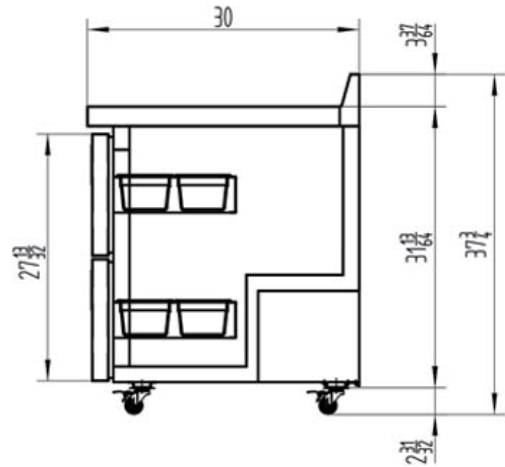
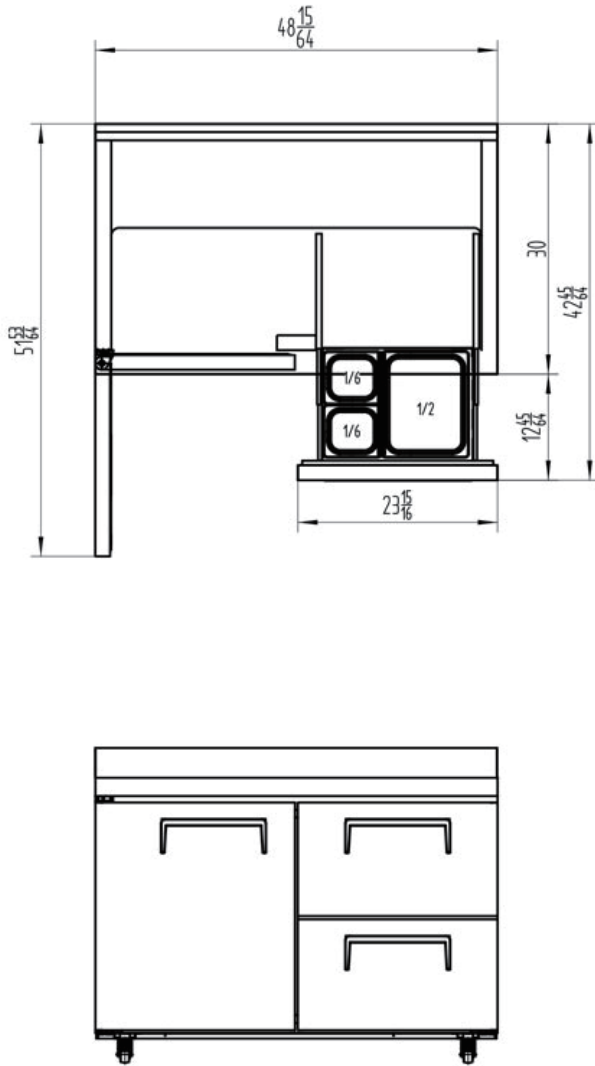

Model	Refrigerant	Doors	Shelves	Dimension (mm) (inch)			HP	Voltage	Amps	Capacity (L) (Cu Ft.)	Net Weight (KG) (LBS)	Temperature Range
				L	D	H						
CWDW2-48VC	R290	1	1	1225	762	959	1/6	115/60	4.2	340	110	1 ~ 8°C
				48.2	30.0	37.8				12.0	242	33 ~ 45°F

Specifications subject to change without notice.